

# PREXISO

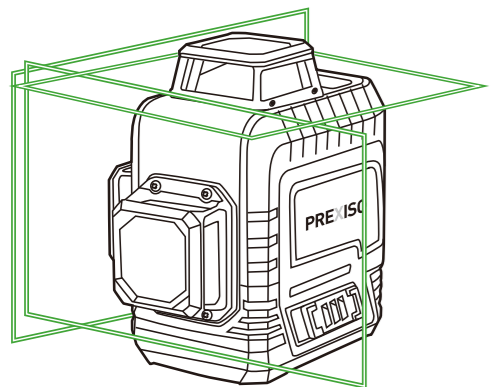

PLC3-360GC

## RECHARGEABLE GREEN-BEAM 3 PLANES CROSS LINE LASER LEVEL



www.prexiso-eu.com

PLC3-360GC-05REV01-2407

### SAFETY INSTRUCTIONS

Working safely with the measuring tool is possible only when the operating and safety information are read completely and instructions contained herein are strictly followed. Never make warning labels on the measuring tool unrecognizable. **SAVE THESE INSTRUCTIONS.** Caution – The use of operating or adjusting equipment or the application or processing methods other than those mentioned herein, can lead to hazardous radiation exposure.

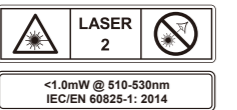

Complies with 21 CFR 1040.10 and 1040.11 except for conformance with IEC 60825-1 Ed. 3, as described in Laser Notice No. 56, dated May 8, 2019.



### WARNING

**LASER RADIATION.** Do not stare into beam. Class II laser product. Turn the laser beam on only when using this tool.

- Do not remove or deface any product labels.
- Avoid direct eye exposure. The laser beam can cause persons being blinded.
- Do not operate the tool around children or allow children to operate the tool.
- Do not place the tool in a position that may cause anyone to stare at the laser beam, whether intentionally or unintentionally.
- Do not use on reflecting surfaces such as sheet steel, glass or polished metal etc. that have shiny, reflective surfaces. The shiny surface could reflect the beam back at the operator.
- Always turn the laser tool off when not in use. Leaving the tool on increases the risk of someone inadvertently staring into the laser beam
- Do not attempt to modify the performance of this laser device in any way. This may result in a dangerous exposure to laser radiation.
- Do not attempt to repair or disassemble the laser-measuring tool. If unqualified persons attempt to repair this product, serious injury may occur. Any repair required on this laser product should be performed only by qualified service personnel.
- Use of other accessories that have been designed for use with other laser tools could result in serious injury.
- Do not operate the tool outdoors.

- Do not place or store tool under extreme temperature conditions.
- Do not operate the tool in explosive environments, such as in the presence of flammable liquids, gases or dusts. Sparks can be created in the tool which may ignite the dust or fumes.
- Keep the tool away from cardiac pacemakers. The magnet inside the tool generates a field that can impair the function of cardiac pacemakers.
- Keep the tool away from magnetic data medium and magnetically-sensitive equipment. The effect of the magnetic can lead to irreversible data loss.
- Measurement may not be accurate if used beyond the rated range of the device.
- The use of optical instruments with this product will increase eye hazard.
- Always make sure any bystanders nearby aware of the dangers of looking directly into the measuring tool.
- Do not use the laser viewing glasses as safety goggles, they do not protect eyes against laser radiation.
- Always remove the batteries when cleaning the laser light aperture to laser lens.

### TECHNICAL SPECIFICATIONS

COMPONENT	SPECIFICATIONS
Laser	$\lambda=510-530$ nm, Class II laser, maximum laser output<1mW
Operating range (typically)	82FT/25M(under 100LUX indoor environment)*
Accuracy (typically)	$\pm 5\text{mm}@10\text{m}$ ( $\pm 3/16"$ @32ft )
Self-leveling range	$\pm 4^\circ \pm 1.5^\circ$
Estimated battery life	>3.5h (Lithium-ion battery)
Optimum operating temperature	14°F to 104°F (-10°C to 40°C)
Storage temperature	-4°F to 140°F (-20°C to 60°C)
Batteries	Rechargeable Lithium-ion battery

\*Important: The accuracy is rated within distance of 10 meters. Under unfavorable conditions, such as in extreme interior illumination, transparent surfaces (eg. glass, water), porous surfaces (eg. insulation materials) or reflecting surfaces (eg. polished metal, glass) or very rough surfaces (eg. rough cast, natural stone), the tool's measuring range and accuracy will be reduced.

### DESCRIPTION

**RECHARGEABLE GREEN-BEAM 3 PLANES CROSS LINE LASER LEVEL**  
This 3 planes cross line laser level is a highly versatile tool. It can be placed on the ground, mounted on a door frame or work bench etc.when use the appropriate accessories eg. wall mount, tripod etc.  
• Self-leveling levels within +4 degrees ( $\pm 1$  degree) to -4 degrees with an accuracy of  $\pm 5\text{mm}@10\text{m}$  ( $\pm 3/16"$  @32ft ).  
• Rechargeable Lithium-ion battery.

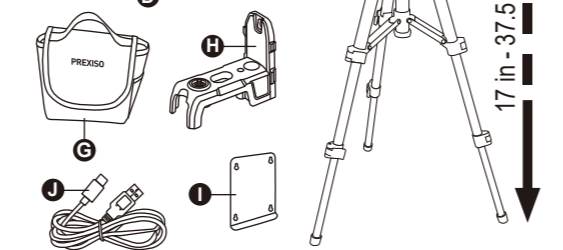
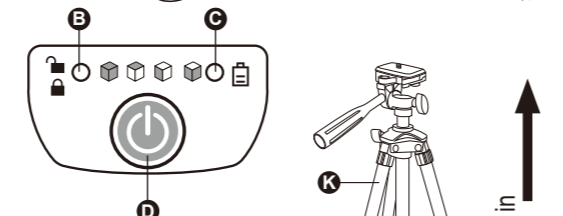
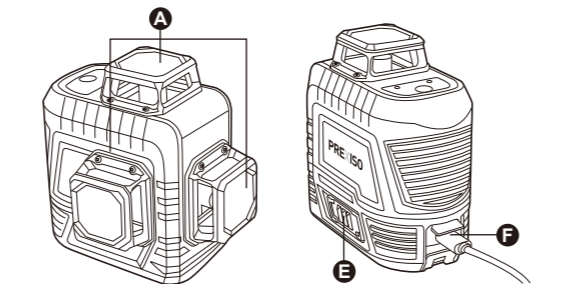

PARTS	DESCRIPTION
A	Laser beam outlet aperture
B	Pendulum / transport lock indicator
C	Low battery indicator
D	Manual mode: Power ON / Line switch Self-leveling mode: Line switch Available 4 leveling modes (1-Horizontal laser plane, left-hand side vertical laser plane and front vertical laser plane, 2-Horizontal laser plane, 3-Front vertical laser plane, 4-Left-hand side vertical laser plane and front laser plane)
E	Power ON / OFF and transport lock / release key
F	Charging port
G	Handy cloth bag
H	Magnetic mounting base
I	Iron wall mount plate
J	Type-C cable wire
K	Tripod(included)

### UNPACKING

- When unpacking the box, do not discard any packing materials until all of the contents are accounted for:
- Rechargeable green beam 3 planes cross line laser level
  - Magnetic wall mount
  - Type-C cable wire
  - Handy cloth bag
  - Operator's manual
  - Iron wall mount plate
  - Tripod(included)

Carefully lift the compact laser measuring tool out of the package and place it on a stable, flat surface.

### ASSEMBLY

#### Measuring Tool Power Supply

The measuring tool can be charged with the included Type-C cable wire.

#### Charge the measuring tool

- Use the included Type-C cable wire to charge the measuring tool.
- When the measuring tool is being charged with Type-C cable wire, the LED light(C) turns red.
- When the measuring tool is fully charged, the LED light(C) turns green.
- When the Type-C cable wire is unplugged from the measuring tool, the LED light(C) goes out.

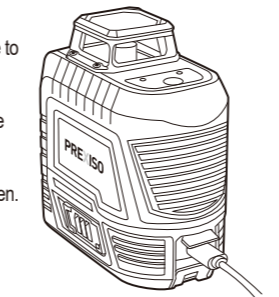

Note: The measuring tool is supplied partially charged.

For storage, it is greatly recommended that recharge the battery at least once in 3-6 months to preserve battery life span.

To ensure full power capacity, fully charge the measuring tool before using your tool for the first time. The tool can be charged at any time without reducing its service life.

### OPERATION

#### Automatic operating mode

When the measuring tool is under switch-off status, slide the switch to the direction of the ON side, the measuring tool is switched on and horizontal and vertical laser planes are generated. The measuring tool has 4 available operating modes which you can switch between at any time by short pressing the button.

At automatic operating mode, the smart pendulum system automatically corrects irregularities of  $\pm 4^\circ \pm 1.5^\circ$  within the self leveling area.

When the measuring tool deviates by more than  $\pm 4^\circ \pm 1.5^\circ$  from horizontal, the self leveling will fail with the LED indicator B turning red and the laser beams flashing.

Slide the switch to the direction of the OFF side, the measuring tool is switched off.

#### Manual operating mode

When the measuring tool is under switch-off status, press the button for 3 seconds, the measuring tool is switched on and the pendulum/transport is locked. 4 available operating modes (D) can be switched between at any time by short pressing the button. Under such circumstances, the pendulum/transport lock LED Indicator B is red, and the measuring tool can not be leveled automatically. Slide the switch to the direction of the ON side, the pendulum/transport lock LED is green, and the measuring tool can be leveled automatically.

The measuring tool can be switched off by sliding the switch to the direction of ON side or by pressing the button for 3 seconds when the switch is on the direction of the OFF side.

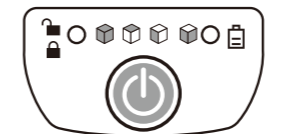

### USING WITH THE CLAMP, WALL MOUNT OR TRIPOD

This compact laser measuring tool is designed with magnetic bracket, you can use the iron wall mount plate to connect and fix the tool on the wall surface by nailing.

At the bottom of the tool, a 1/4"-20 nut is located. Mount the tool to accessories like clamp, or tripod (included) by assembling the tool nut with the 1/4"-20 screw on the accessories. With the accessories, the tool can work under various applications which makes jobs done easier.

**Note:**  
Make sure the tool can be assembled on the accessories without damage or interference to any part of the Self-leveling cross line laser or the accessories.

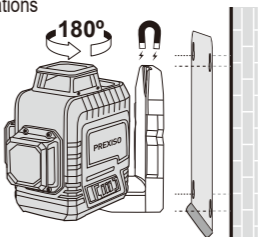

### APPLICATIONS

The compact self-leveling cross line laser can be placed on the ground, mounted on a work bench / door frame etc. for point marking and simple alignment by sight. It is ideal for the following applications:

- Hanging pictures, photos, or artwork on walls
- Wallpapering and stencil work
- Framing doors and windows
- Installing electrical wiring and pipes
- Mounting wall fixtures, electrical outlets, switches and lighting
- Installing a drop ceiling
- Painting
- Installing cabinets
- Laying tile and flooring

### MAINTENANCE

This compact laser measuring tool has been designed to be a low-maintenance tool. However, in order to maintain its performance, you must always follow these simple directions:

- Avoid exposing the tool to shock, continuous vibration or extreme hot or cold environment.
- Always store the tool indoors.
- Always keep the tool free of dust and liquids. Use only a clean soft cloth for cleaning. If necessary, slightly moisten the cloths with pure alcohol or a little water.
- Do not disassemble the compact laser measuring tool, this will expose the user to hazardous radiation exposure.
- Do not attempt to change any part of the laser lens.

### TROUBLE SHOOTING

PROBLEM	CAUSE	SOLUTION
LED light C flashes in red	Short of power.	Charge the tool.
The laser line is hard to see.	The tool is out of the rated operating range.	Move the tool closer to be within the rated operating range.
Laser line is not projected.	No power.	Charge the tool.
The laser lines are blinking and LED light B is flashing in red at automatic operating mode.	The surface where the tool has been placed is uneven or the tool is out of its automatic self-leveling range.	Place the tool on flat surface levels within +/-4 degrees.

### DISPOSAL

#### CAUTION

The batteries must not be disposed with household waste. Care for the environment and take them to the collection points provided in accordance with national or local regulations. Dispose of the product appropriately in accordance with the national regulations in force in your country. Adhere to the national and country specific regulations.

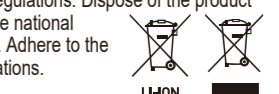

### WARRANTY

Two-Year Limited Warranty. This product is warranted to the original purchaser from the original purchase date for two years subject to the warranty coverage described herein. Please retain your receipt. This product is warranted to the original user to be free from defects in material and workmanship. If you believe that the product is defective at any time during the specified warranty period, please contact Prexiso customer service agent by sending email to info@prexiso-eu.com. This warranty does not cover: (1) Part failure due to normal wear or product abuse; (2) Any parts have been altered or modified by anyone other than an authorized Prexiso personnel or failure to install and operate equipment according to the guidelines put forth in the instruction manual. (3)Any products or parts used for rental purposes, damage resulting from shipping (claims must be filed with freighter), accident, abuse, act of God, misuse, or neglect. Prexiso will replace or repair the defective unit, at its option, subject to verification of the defect. Any implied warranties arising from the sale of a Prexiso product, including but not limited to implied warranties of merchantability and fitness for a particular purpose, are limited to the above. Prexiso shall not be liable for loss of use of the product or other incidental or consequential damages, expenses, or economic loss, or for any claim of such damage, expenses, or economic loss. This warranty excludes any accessories. This warranty gives you specific legal rights, and you may also have other rights that vary from state.

